

Improving SRC with Capacitor Bypassing Method for Universal AC-DC Adapter

Yang Chen, Hongliang Wang, Yan-Fei Liu, *Fellow, IEEE*, P. C. Sen, *Life Fellow, IEEE*
Department of Electrical and Computer Engineering
Queen's University, Kingston, Canada
yang.chen@queensu.ca, hongliang.wang@queensu.ca,
yanfei.liu@queensu.ca, senp@queensu.ca

Xiaodong Liu
College of Electrical Engineering,
Anhui University of Technology, Ma-An Shan, China
liuxiaodong@ahut.edu.cn

Abstract— Technologies associated with power adapters for laptops and cellphones are fast advancing with new protocols and devices unveiled. A universal adapter operating from 100 VAC to 240 VAC has long been a prized feature among consumers, yet a challenge for the designers. This paper proposed a series resonant converter with capacitor bypassing method to accommodate the wide AC voltage range, and achieve high performance. Two resonant capacitors are used for the 120 VAC and 220 VAC lines, respectively. Thus, the resonant inductor size and loss can be significantly reduced as compared to the conventional series resonant converter. This technology is easy to implement in terms of both circuitry and control. The added MOSFET and capacitor are of low voltage rating, and consumes minimum board area. A 30 W prototype was built to verify the feasibility and demonstrate the advantages. A 93.3% efficiency is achieved with silicon operating at 1-MHz level.

Keywords— universal; power adapter; SRC; series resonant converter; wide voltage; power delivery; USB PD

I. INTRODUCTION

The demand is ever-increasing for high-performance small-size power adapters for laptops and cellphones, as the market leaders such as Google and Qualcomm promoting their fast-charging protocols and devices [1]–[3]. With the market rapidly growing, the converter design faces new challenges. One of the issue is to accommodate a wide input voltage range as well as a wide output voltage range. While the newest USB Power Delivery (PD) standard requires a variable DC output voltage from 5 V to 20 V [4], the input AC voltage usually varies as wide as 100-240 VAC, bringing great challenges for efficiency optimization and size reduction.

With the advances of semiconductor fabrication, CPUs nowadays consumes less power. Today, adapters' power profile is de-rated to 60 W level without mandatory power factor correction [5]. At such power level, topology selection is still debatable. Much as the Flyback gains efficiency improvement with the active clamp technique [6], the cost-effectiveness degrades, and approaches that of the half-bridge LLC converter. On the other hand, half-bridge LLC has lower current stress, easier implementation of soft switching, and better transformer performance [7].

At 60 W power, series resonant converter (SRC) maintains the major good performance of LLC converter, and outperforms in various aspects. For example, SRC has generally lower current stress due to removal of circulation current and the critical continuous secondary current; easier ZVS and tolerable to slow turn-off transient (dv/dt), enabling silicon operating at MHz; and smaller transformer size due to the removal of air gap and less windings. The main drawback, however, is the much larger resonant inductor value as compared to LLC. This can be generally attribute to two reasons: 1), SRC's resonant frequency is always lower than LLC, given same design of switching frequency range; 2), naturally flatter gain curve of SRC. If a small resonant inductor is used, the converter simply cannot accommodate the wide AC line voltage of 100-240 VAC within a reasonable switching frequency range.

This paper focuses on solving the wide AC input voltage problem with SRC converter and capacitor bypassing. Two resonant capacitors are used respectively for the two AC lines – 120 VAC and 220 VAC. With the capacitor bypassing method, a small inductor can still be used, so that the inductor size and loss can be reduced significantly. Besides, the added capacitor and MOSFET is of very small footprint and low cost, which will be shown in the prototype later.

II. PRINCIPLE AND ANALYSIS OF THE PROPOSED FB-VD RECTIFIERS

Fig. 1 shows the topology of SRC with capacitor bypassing. Different from the conventional SRC, the converter contains two resonant capacitors C_{r1} and C_{r2} . Besides, the MOSFET Q_3 operates in on/off mode to select the proper resonant capacitor(s) for different AC lines. Other setup is the same as conventional half-bridge SRC converter with full-bridge front rectifier, center-tapped transformer and synchronous rectifiers (SR) on the secondary side.

Full-bridge rectifier plus an electrolytic capacitor is a common combination used after the AC input. For 120 VAC line, maximum designed DC input voltage on the capacitor C_{in} is 200 V, considering the line could fluctuate to 140 VAC. The minimum capacitor voltage ($V_{in,min}$) is an important design parameter in AC-DC applications. Using a small $V_{in,min}$ can

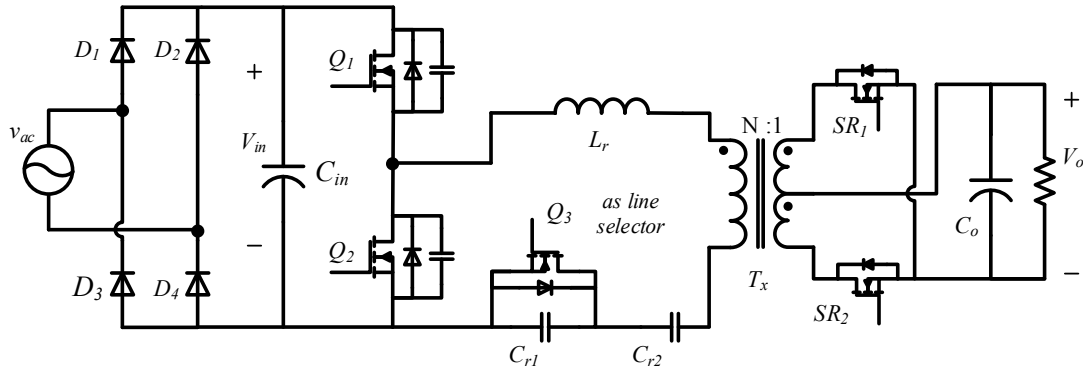

Fig. 1. Proposed topology of SRC converter with capacitor bypassing for AC-DC power adapter

reduce the capacitor and converter size, but aggravate the gain design. In this case, the V_{in_min} is selected as 100 V, which is believed a reasonable trade-off between the size and the design. For 220 VAC line, the maximum input voltage is 340V at line peak of 240 VAC. With the same C_{in} design, the minimum input voltage for 220 VAC line is 250 V.

As shown in Fig. 2, to accommodate 100-340 V, resonant inductor L_r of 60 μH should be used to limit the frequency range within 500-900 kHz. If a smaller L_r is used, it either cannot cover the entire input voltage range, or needs to increase the switching frequency range to a great extent, which in practical makes the whole optimization very difficult to achieve.

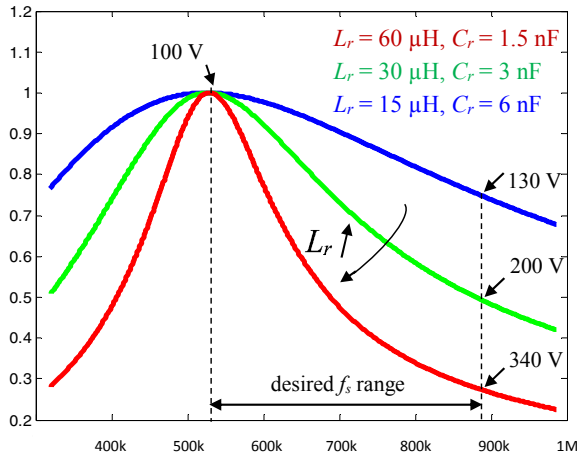

Fig. 2. SRC gain curve with different L_r and same f_s range

As the 120 VAC and 220 VAC are two independent cases, two resonant tanks can be used to respectively address the two input conditions. Preferably, two different resonant capacitors should be used with the same inductor, because the resonant capacitor is much smaller in terms of physical size. With the two AC line addressed separately, the resonant inductor value can be significantly reduced, because effectively only 120 VAC line determines the design.

For 120 VAC line, a small resonant capacitor C_r should be used, while for 220 VAC line, a large C_r should be used, so that the resonant tank becomes more inductive. With the circuit shown in Fig. 1, C_{r1} should be smaller than C_{r2} . At 120 VAC, the MOSFET Q_3 remains off, the equivalent C_r value is $C_{r1} * C_{r2} / (C_{r1} + C_{r2})$. This set of parameter only need to cover the 110 VAC line with a DC range of 100-200 VDC. At 220 VAC, the MOSFET Q_3 is on, and C_{r2} alone serves as the resonant capacitor. The required DC voltage range is 250-340 VDC.

Fig. 3 shows the gain curves of SRC with capacitor bypassing for the two AC lines. C_{r1} and C_{r2} value are 3.6 nF and 40 nF respectively, and the equivalent C_r value is 3 nF for 110 VAC and 40 nF for 220 VAC. The actual inductor value needed is 30 μH , which is only half of the 60 μH inductor in the conventional SRC converter. If designing the two inductors with the same core and same winding, the flux in the 60 μH inductor will be 2 times its counterpart due to $\Phi = LI$, making the core loss more than 4 times higher. If maintaining same core loss, then the copper loss will be 4 times higher, because the winding need to be of twice length with half section area.

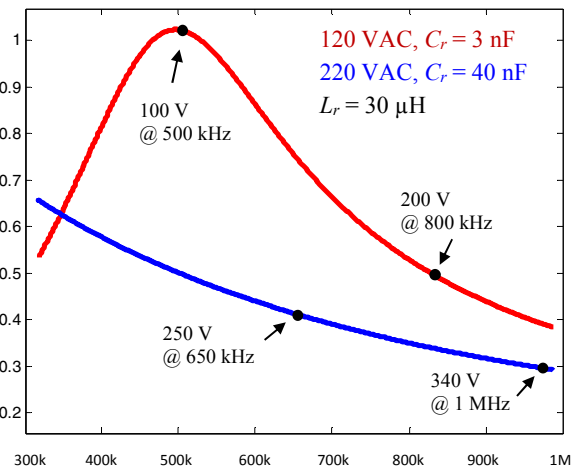

Fig. 3. SRC gain curves with different C_r for two AC lines

III. CHANGE OF CIRCUIT BEHAVIOR DUE TO BODY DIODE OF THE AUXILIARY SWITCH

When the converter is operating with 220 VAC line, the switch Q_3 is turned on. Thus, all the parasitic components of Q_3 are ineffective.

When the converter is operating at 120 VAC line, Q_3 will be turned off, then the impact of the parasitic components should be considered. The parasitic capacitor is directly paralleled to the C_{r1} , thus, can be neglected for the most part. The body diode, however, has critical influence on the circuit behavior, because the previous experience shows that the diode should change the charging and discharging of a capacitors that is paralleled to it.

Despite the body diode conducts or not, the resonant current should be of an AC shape alternating at switching frequency. For simple understanding, a sinusoidal current is used for the analysis. Thus, the voltage across C_{r1} and C_{r2} should also be sinusoidal. Besides, for half bridge, the capacitor should bear a DC bias, V_{bias} , whose value equals to half of the input DC voltage. Thus, a simplified model of C_{r1} and C_{r2} voltage stress at 120 VAC can be found in Fig. 4. In this model, the AC voltage source v_{Cr_pk} is defined by the peak value of the AC component on the two resonant capacitors. D_{b3} is the body diode of the auxiliary switch Q_3 .

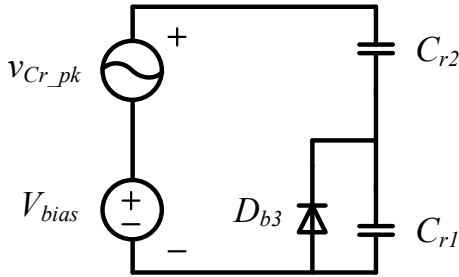

Fig. 4. Simplified model of resonant capacitor and bode diode at 120 VAC

Depending on whether D_{b3} conducts, two conditions should be considered. The boundary of the two conditions is $V_{bias} = v_{Cr_pk}$.

1) Condition A: $V_{bias} \geq v_{Cr_pk}$

If the resonant current is low, then the AC component will always be lower than the DC bias, *i.e.* $V_{bias} \geq v_{Cr_pk}$. Then, total voltage stress on the two resonant capacitors is always positive. Thus, the diode D_{b3} is always reverse biased. Equivalently, D_{b3} could be removed. The voltage stress of C_{r1} and C_{r2} is reverse proportional to the capacitor value.

Fig. 5 shows the PSIM simulation result of an example of condition A, in which the total bias voltage $V_{bias} = 100$ V, and the AC component $v_{Cr_pk} = 50$ V for $C_{r1} = 4$ nF and $C_{r2} = 36$ nF.

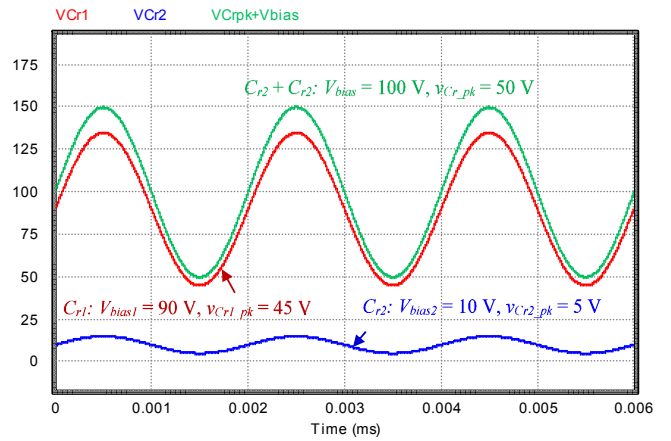

Fig. 5. Voltage stress of resonant capacitors for $V_{bias} \geq v_{Cr_pk}$

As the capacitance ratio of C_{r1} and C_{r2} is 1:9, the impedance will be 9:1. Based on the voltage divider theory, C_{r1} should assume 90% of the total voltage stress – both the DC and AC components, and C_{r2} should assume 10%. Thus, for C_{r1} , the bias voltage $V_{bias1} = 90$ V, and the AC component $v_{Cr1_pk} = 50$ V. And for C_{r2} , the bias voltage $V_{bias2} = 10$ V, and the AC component $v_{Cr2_pk} = 5$ V.

2) Condition B: $V_{bias} < v_{Cr_pk}$

In the condition that $V_{bias} < v_{Cr_pk}$, the minimum voltage stress on the two capacitors is negative. If no body diode is presented, the voltage distribution on the two capacitors will still be determined by the capacitor value in a reverse-proportional manner, despite the direction. Fig. 6 shows the voltage stress of the two resonant capacitors without body diode, for $V_{bias} < v_{Cr_pk}$.

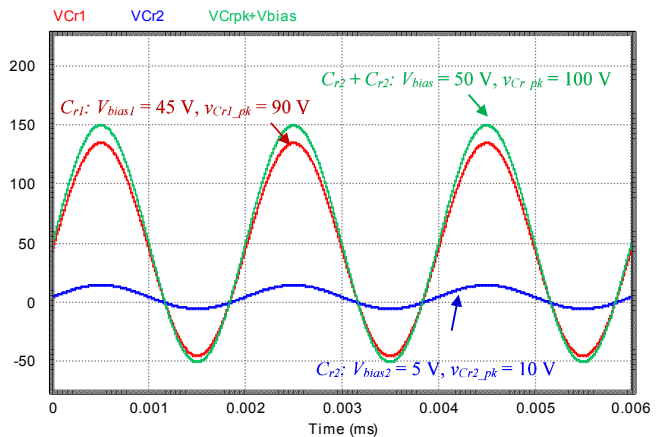

Fig. 6. Voltage stress of resonant capacitors for $V_{bias} < v_{Cr_pk}$ (without diode)

When body diode is added in parallel with C_{r1} , C_{r1} voltage is always clamped as positive. As can be observed in Fig. 7, at $t = 0$, the two capacitors store no energy. Thus, in the first cycle when the total voltage is above zero, the two capacitors' voltage stress is reverse-proportionally distributed, despite being charged or discharged.

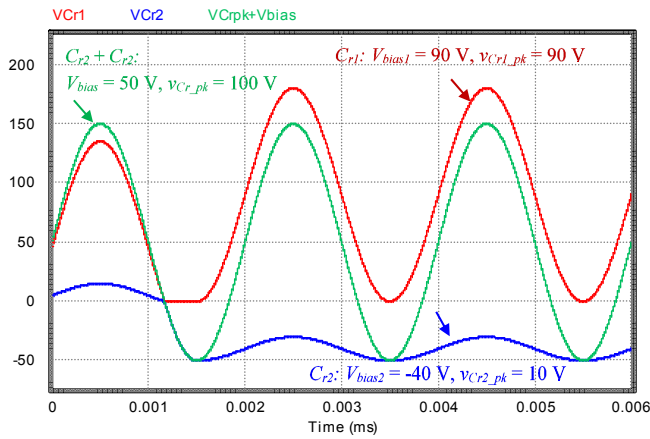

Fig. 7. Voltage stress of resonant capacitors for $V_{bias} < v_{Cr_pk}$ (with diode)

As the total voltage reduces to negative, the D_{b3} will conduct. Thus, voltage across C_{r1} is clamped to zero. As the voltage is reducing, the capacitors are discharging, and C_{r2} bears all the negative voltage. Until the total voltage stress reaches the minimum, the two capacitors started to be charged again. During the charging process, D_{b3} remain reverse biased, and the charging current must go through the series connected C_{r1} and C_{r2} simultaneously. Thus, the voltage variation on C_{r1} and C_{r2} maintain as reverse-proportional to the capacitor value. As the starting point is zero for C_{r1} voltage, after a symmetrical cycle of charging and discharging, the voltage at the ending point is still zero for C_{r1} . Once the steady state is reached, the body diode D_{b3} should not conduct again. Thus, with the body diode, the AC voltage stress for C_{r1} and C_{r2} is still reversely proportional to the capacitor value, while the DC bias is changed to maintain minimum voltage on C_{r1} as zero. As the current in the two resonant capacitors are same in steady state, it is concluded that the body diode only changes the DC bias.

In a nutshell, the body diode has no impact on the circuit behavior when the resonant current/load current is low, *i.e.* the AC voltage stress is lower than the DC bias ($V_{bias} > v_{Cr_pk}$). Otherwise, the body diode will conduct for a short period during the transient, and clamp the voltage on C_{r1} always as critical positive. The DC bias on two resonant capacitors will then be re-distributed, and the AC component remain unchanged. This does not have an impact on the resonant current/load current.

IV. DISCUSS OF ALTERNATIVES

This section discusses the topology alternatives that have the same principle as that of the SRC with resonant capacitor bypassing.

A. Two Capacitors in Parallel

As shown in Fig. 8, C_{r1} and C_{r2} are connected in parallel instead of in series as shown in Fig. 1. Q_3 is connected in series with C_{r2} , and used as an AC line selector between 120 VAC and 220 VAC lines.

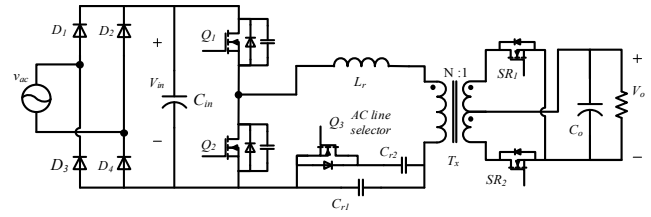

Fig. 8. SRC with two resonant capacitors connected in parallel

For 120 VAC, Q_3 is turned off, and only C_{r1} serves as the resonant capacitor, which should be of a small value. In 220 VAC line, Q_3 is turned on, so that C_{r1} and C_{r2} are connected in parallel, and the total resonant capacitor value is $C_{r1} + C_{r2}$. The body diode will also change the DC bias of C_{r1} and C_{r2} during transient. But in steady state, the impact could be neglected.

As compared to the series connected structure as shown in Fig. 1, for same effective resonant capacitor design, the peak voltage stress on Q_3 in Fig. 8 is slightly higher at 120 VAC when it is turned off. This is because, for the paralleled structure, Q_3 withstands the total voltage stress. While for the two capacitors connected in series, Q_3 withstands a part of the total stress.

B. SRC with Inductor Bypassing

The SRC with an inductor bypassing structure is also worth exploring to make the theory consistent and complete. Fig. 9 shows the SRC with two resonant inductors connected in series. For 120 VAC, L_{r1} is used as the resonant inductor. For 220 VAC, L_{r1} and L_{r2} in series serve as the resonant inductor, whose value equals to $L_{r1} + L_{r2}$. To switch between the two AC lines, Q_3 and Q_4 must be used with a back-to-back configuration. Otherwise, the inductor should have DC bias current, which is not acceptable. Switches Q_3 and Q_4 should be turned on and off simultaneously. In practice, L_{r1} could be the leakage inductor from the transformer, while L_{r2} should be external.

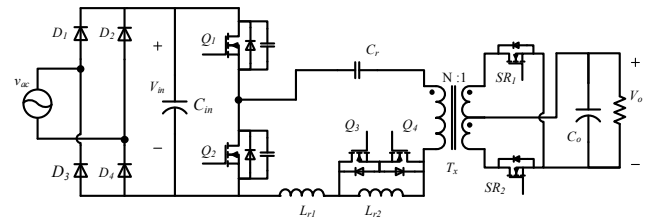

Fig. 9. SRC with two resonant inductors connected in series

Similarly, the two inductors can also be connected in parallel. As shown in Fig. 10, the AC line selector switches Q_3 and Q_4 is in series with L_{r2} . At 120 VAC, Q_3 and Q_4 should be turned off. The total inductor value is $L_{r1} * L_{r2} / (L_{r1} + L_{r2})$. For 220 VAC case, Q_3 and Q_4 should be turn on. Thus, L_{r2} is short circuit and L_{r1} alone serve as the resonant inductor. In this case, the two inductors must be external. It should be noted that two inductors in parallel is not a practical solution, although it is technically viable.

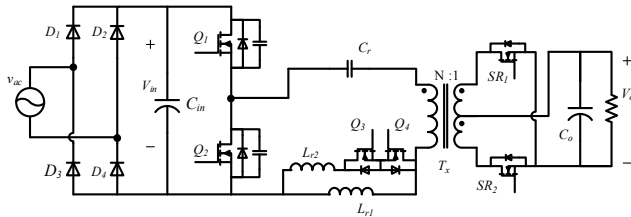

Fig. 10. SRC with two resonant inductors connected in parallel

C. Comparison of Capacitor Bypassing and Inductor Bypassing Methods

Both capacitor bypassing and inductor bypassing methods use two sets of resonant tanks for 120 VAC and 220 VAC. It must be guaranteed that small resonant capacitor/inductor value is used for 120 VAC, and large value is used for 220 VAC, such that the resonant frequency for 220 VAC is lower than the 110 VAC case. Then, the voltage gain can be reduced for 220 VAC.

In terms of effectiveness, inductor bypassing method is more effective than the capacitor bypassing method, in that only a small add-on value is needed to achieve enough gain dip for 220 VAC. The gain curves of SRC converter with different capacitors and inductors are shown in Fig. 11 and Fig. 12. The parameter of $L_r = 30 \mu\text{H}$ and $C_r = 3 \text{ nF}$ is used as the reference. In Fig. 11, the capacitors are increased to 4 nF and 5 nF. At 900 kHz, the minimum voltage gain with 4 nF is 0.43, and that of 5 nF is 0.41. As comparison, in Fig. 12, by changing the inductors to 40 μH and 50 μH , the voltage gain dives deeper in the desired frequency range. At 900 kHz, the minimum voltage gain with 40 μH is 0.34, and that of 50 μH is 0.25.

The reason that inductors have more significant impact than capacitors is that the SRC converter is operated in the inductive region, *i.e.* higher than resonant frequency. If operating at the capacitive region, *i.e.* lower than resonant frequency, it could be observed that changing capacitor would have more impact on the gain.

From the point view of size, cost reduction and simplicity, the capacitor bypassing method is a better choice. The reason can be found as follows.

1. Only one MOSFET is needed for the SRC converter with capacitor bypassing method, while two MOSFET must be used for the SRC converter with inductor bypassing, although both could be of low voltage rating.
2. The MOSFET used in the capacitor bypassing method is ground referenced, thus the driver design is much simpler than that in the inductor bypassing cases.
3. In practice, capacitor is much smaller in physical size than inductors. In fact, the resonant inductor is one of the bulkiest components in the prototype. Thus, from the stand of size, capacitor bypassing method should be selected.

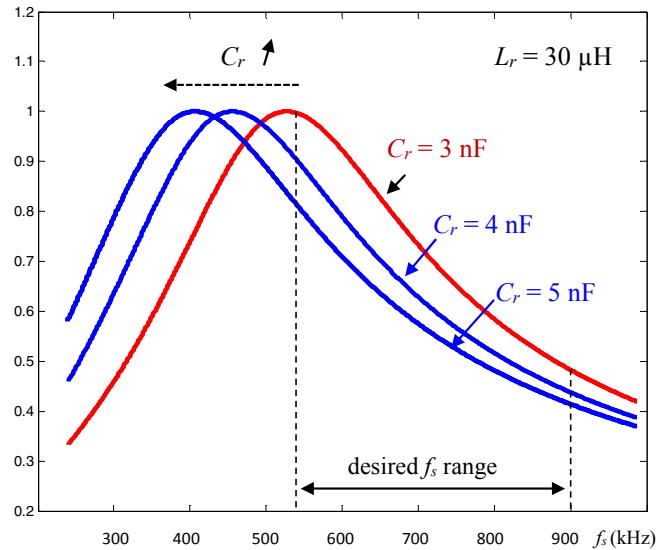

Fig. 11. SRC converter with different capacitors

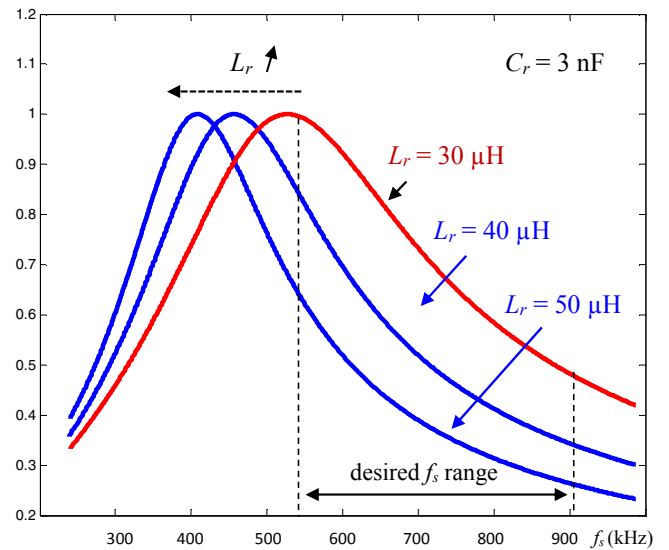

Fig. 12. SRC converter with different inductors

V. EXPERIMENT RESULTS

A 100 – 240 VAC input, 10 V/30 W output prototype was built to verify the feasibility and demonstrate the effectiveness of the proposed SRC with capacitor bypassing. The detailed design specification and power train parameters are given in 0.

Fig. 13 shows the prototype of the SRC with capacitor bypassing. It should be noted here that the footprints are very small for the added MOSFET Q_3 (available in 3mm by 3mm) and C_{r2} (1206), which is favored in size stringent applications such as power adapters.

Table I. SPECIFICATIONS OF SRC WITH CAPACITOR BYPASSING

Input AC voltage	100VAC – 240VAC
Switching frequency range	500 kHz – 1 MHz
Output voltage / power	10V / 30W
Input capacitor C_{in}	47 μ F / 450 V
Resonant inductor L_r	30 μ H (20 T / RM6)
Resonant capacitors C_{r1} / C_{r2}	3.6 nF / 40 nF
Transformer turns ratio N_{tx}	10:2:2 (RM6)
HB MOSFETs	IPD65R400CE
SR MOSFETs	BSC034N03LSG
Auxiliary MOSFET	BSC320N20NS3G

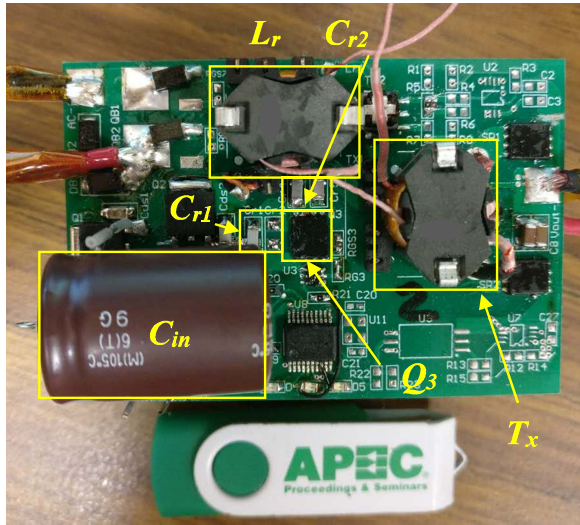
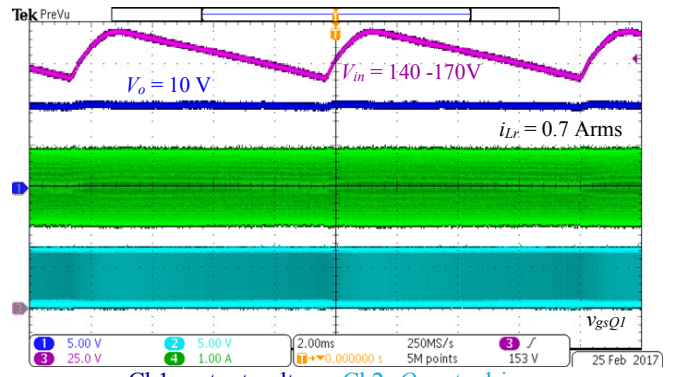

Fig. 13. Prototype of the proposed SRC with capacitor bypassing

The 120 VAC, 60 Hz operation waveform of the SRC converter is shown in Fig. 14. The voltage on the input capacitor C_{in} varies from 140 V to 170 V. For 120 VAC line, the auxiliary switch Q_3 is turned off, and the effective resonant capacitor value is 3.3 nF. The resonant inductor current has a peak value of 1 A, and the measured RMS value is 0.7 A. As can be observed, the output voltage can be well regulated at 10 V.

The zoom-in waveforms at 140 V and 170 V DC input is shown in Fig. 15 and Fig. 16 at switching frequency level. The switching frequency for 140 V and 170 V are respectively 650 kHz and 725 kHz, which is also the switching frequency range for the 120 VAC operation. As the switching frequency increases, the resonant current has similar magnitude, because of the same load current. Besides, it can be observed that, over the entire input voltage range, ZVS operation of the primary switches is well maintained.



Ch1: output voltage; Ch2: Q_1 gate drive;
Ch3: capacitor voltage; Ch4: resonant current
Fig. 14. SRC converter with capacitor bypassing for 120 VAC with 3.3 nF capacitor and Q_3 off

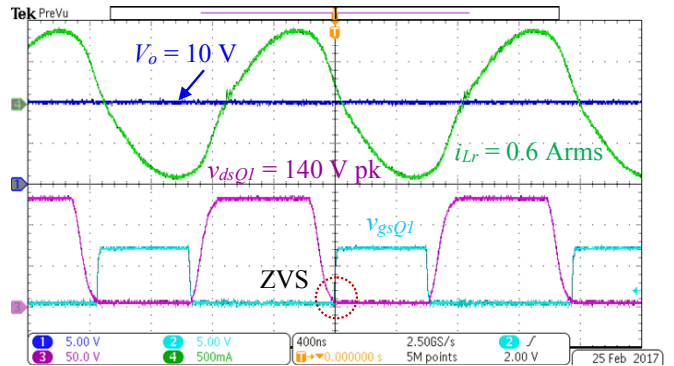

Ch1: output voltage; Ch2: Q_1 gate drive;
Ch3: capacitor voltage; Ch4: resonant current
Fig. 15. Waveform at 140V DC with 3.3 nF resonant capacitor at 30 W load with Q_3 off

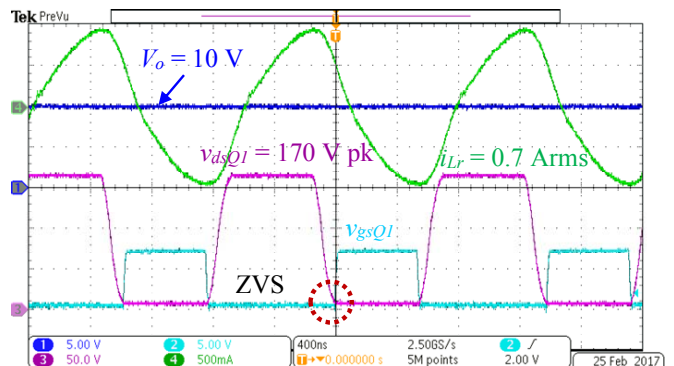

Ch1: output voltage; Ch2: Q_1 gate drive;
Ch3: capacitor voltage; Ch4: resonant current
Fig. 16. Waveform at 170V DC with 3.3 nF resonant capacitor at 30 W load with Q_3 off

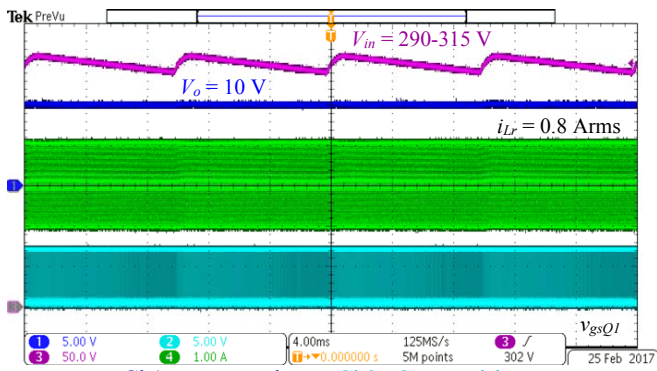

Ch1: output voltage; Ch2: Q_1 gate drive;
Ch3: capacitor voltage; Ch4: resonant current

Fig. 17. SRC converter with capacitor bypassing for 220 VAC with 40 nF capacitor and Q_3 on

At 220 VAC, 50 Hz, Q_3 is turned on, and the effective resonant capacitor is 40 nF. The operation waveform is shown in Fig. 17. The rectified DC input voltage is within 290 V to 315 V. As can be observed, the output voltage is well regulated at 10 V. The resonant inductor current has a peak value of 1.1 A. And the measured RMS value is 0.8 A throughout the input voltage range.

Fig. 18 and Fig. 19 shows the waveforms at 290 V and 315 V input at switching frequency level. The switching frequency for 290 V is 740 kHz, and for 315 V is 815 kHz. As the resonant capacitor is significantly larger, the resonant period is also much longer. Thus, the resonant current is more close to triangular shape rather than sinusoidal. Similar to the 120 VAC case, the resonant current does not change much at different input voltages, as it is determined by the load. As can be observed, over the entire input voltage range, ZVS operation of the primary switches is well maintained.

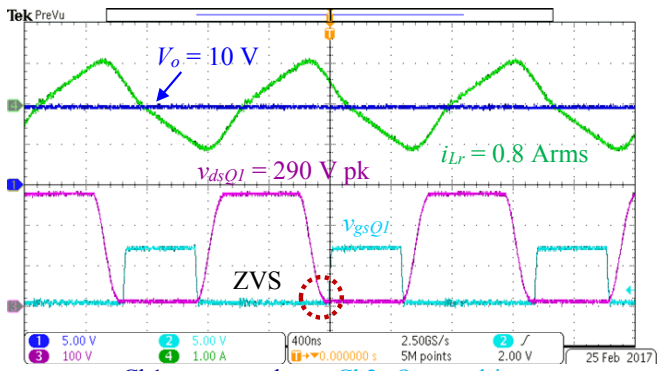

Ch1: output voltage; Ch2: Q_1 gate drive;
Ch3: capacitor voltage; Ch4: resonant current

Fig. 18. Waveform at 290V DC with 40 nF resonant capacitor at 30 W load with Q_3 on

Fig. 20 shows the efficiency for different AC voltages for 120 VAC line. At lower voltage, the rectifier current is high, so the loss is higher. At high voltage, the resonant tank current has higher current stress, so the conduction loss and core loss would increase. The peak efficiency at 93.3% is achieved around the nominal 120 VAC and 130 VAC, which is as desired.

Efficiency at Different AC voltages for 120 VAC Line

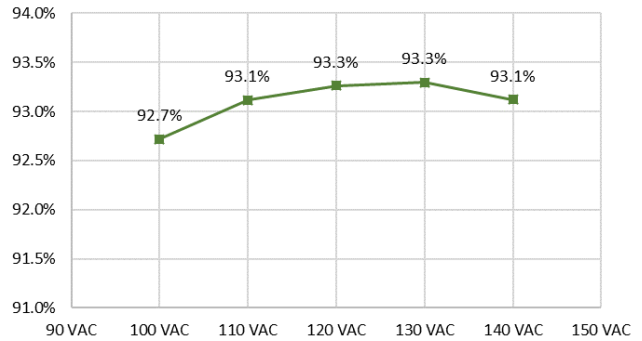
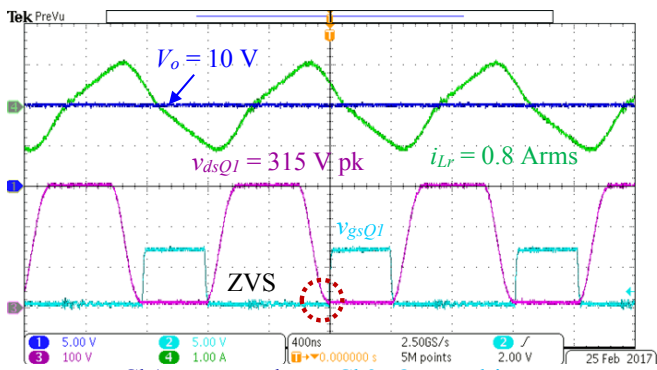

Fig. 20. Efficiency at different AC voltages for 120 VAC line 30 W load



Ch1: output voltage; Ch2: Q_1 gate drive;
Ch3: capacitor voltage; Ch4: resonant current

Fig. 19. Waveform at 315V DC with 40 nF resonant capacitor at 30 W load with Q_3 on

Efficiency at Different AC voltages for 220 VAC Line

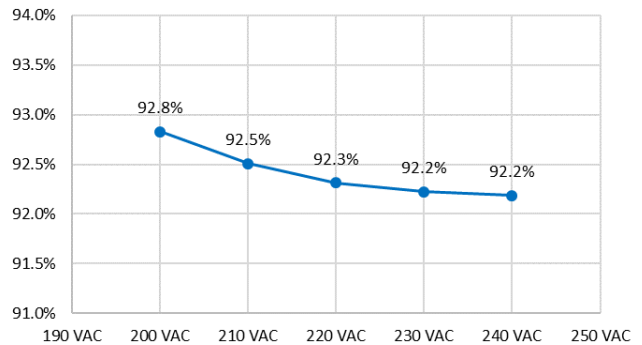

Fig. 21. Efficiency at different AC voltages for 240 VAC line 30 W load

Fig. 21 shows the efficiency for different AC voltages for 240 VAC line. The measured efficiency reduces as the AC voltage going higher. This can be attributed to the increasing switching frequency, which results in higher conduction loss and core loss in the magnetic components as well as higher switching loss in the switching devices.

VI. CONCLUSION

In this paper, a series resonant converter with resonant capacitor bypassing is proposed for universal AC-DC power conversion. Two resonant capacitors are used respectively for the 120 VAC line in North America and 220 VAC line in Europe and China. The technology is easy to implement in terms of both circuitry and control. The added capacitors and MOSFET require minimum board area and space. The additional MOSFET is of low voltage rating, and operates in on/off mode as the line selector. Thus, there is no associated switching loss, and the high frequency performance does not degrade. With two resonant capacitors used, the size and loss of the resonant inductor can be significantly reduced as compared to that of the conventional SRC converter. Besides, in this paper, it is also analyzed and demonstrated of the body diode's influence on the circuit behavior. The conclusion is that only DC bias is changed, while the AC component shows no difference. Thus, the impact can be neglected. In this paper, the inductor bypassing method as the alternative is also discussed and compared to the capacitor bypassing method from the stand of practical design. At last, a 100 – 240 VAC input, 10 V/30 W output prototype based on the capacitor

bypassing has been built to verify the proposed method. The experiment results justify the feasibility and the effectiveness of the topology and analysis in that 93.3% peak efficiency is achieved at 120 VAC with silicon MOSFETs operating at 1 MHz level.

References

- [1] "Global market forecasts examines external AC-DC power supplies", *EE Times*, 2017. [Online]. Available: http://www.eetimes.com/document.asp?doc_id=1263930. [Accessed: 13- Jul- 2017].
- [2] "External Power Adapters and Chargers Report 2014." *IHS Technology*, [Online]. Available: <https://technology.ihs.com/api/binary/511835?attachment=true>. [Accessed: 13- Jul- 2017].
- [3] "External Power Adapters and Chargers 2015." *IHS Technology*, [Online]. Available: <https://technology.ihs.com/525703/external-power-adapters-chargers-2015>. [Accessed: 13- Jul- 2017].
- [4] "A primer on USB Type-C and PD applications and requirements." *TI*, 2016. [Online]. Available: <https://www.ti.com/lit/slyy109>. [Accessed: 13- Jul- 2017].
- [5] "IEC 61000-3-2:2014 electromagnetic compatibility, EMC, smart city, rural electrification." *IEC*, [Online]. Available: <https://webstore.iec.ch/publication/4149>. [Accessed: 13- Jul- 2017].
- [6] X. Huang, J. Feng, W. Du, F. C. Lee and Q. Li, "Design consideration of MHz active clamp flyback converter with GaN devices for low power adapter application," *2016 IEEE Applied Power Electronics Conference and Exposition (APEC)*, Long Beach, CA, 2016, pp. 2334-2341.
- [7] Y. Chen, H. Wang and Y. F. Liu, "Improved hybrid rectifier for 1-MHz LLC-based universal AC-DC adapter," *2017 IEEE Applied Power Electronics Conference and Exposition (APEC)*, Tampa, FL, 2017, pp. 23-30